

CMF Series

PO and PG Furnaces

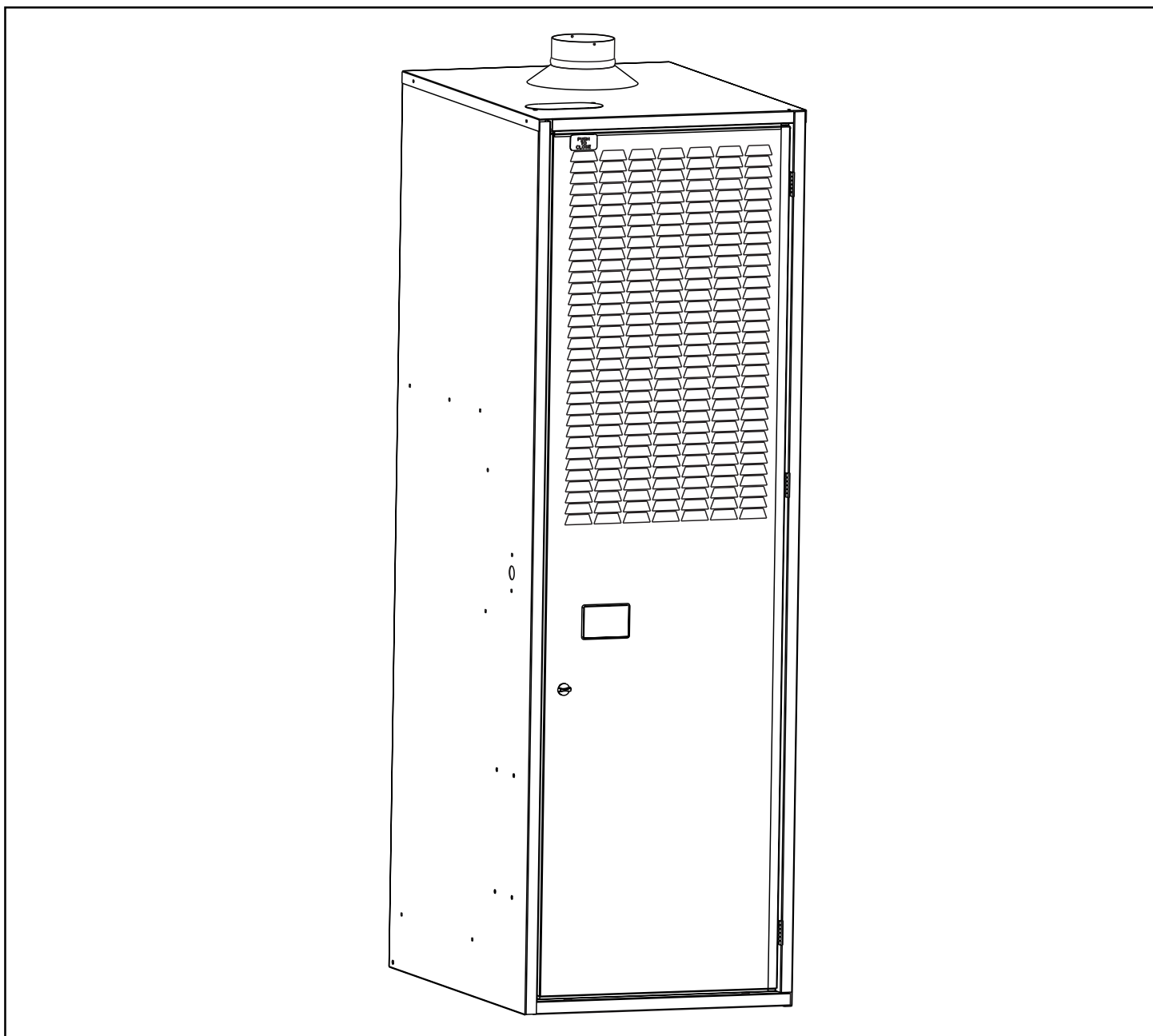

Service Manual

Index

	Page
Introduction	3
Electrical Supply & Polarity	3
Door Switch	4
Fan/Limit Switches	4
Blower Motor	4-5
Oil Burner	5
Oil Pump	5-6
Natural to LP Conversion	6
Igniter (Power Gas Only)	7
Primary Control	7
Cad Cell	8
Ignition Transformer	8
Electrode Setting	9
Combustion Air Band	9
Air Housing, Blower Wheel	10
CB200A Base	10
Troubleshooting Flow Charts	11-15
Service Guide	16-17
Oil to Gas Conversion	18-22
Wiring Diagrams	23-24

CAUTION:

This service manual is primarily intended to assist qualified individuals experienced in servicing heating and air conditioning appliances and is not intended to be used by unqualified personnel.

Performing service as outlined in this service manual will require the use of calibrated test instruments. Using uncalibrated test instruments will result in faulty diagnoses. All instruments should be used in accordance with the manufacturer's instructions.



Figure 1



Figure 2

These instructions are intended for use by qualified individuals specially trained and experienced in installation of this type of equipment and related system components. Installation and service personnel are required by some governing bodies to be licensed. Persons not qualified should not attempt to install or service the equipment, nor interpret these instructions. These furnaces must be installed in accordance with local codes and ordinances.

These furnaces are high quality, direct vent furnaces that are convertible from power oil to power gas. The PO models are Power Oil. The PG models are Power Gas models. Gas models are designed for operation with natural or LP. gas.

The furnaces are Listed by Underwriters Inc. for use in manufactured (mobile) homes and recreational vehicles and as a central furnace, special type when installed with model CB200A outlet Air base.

Standard Flue Furnaces

The current line of furnaces using the standard flue system are the CMF series. This is a heating only, sealed combustion furnace, which draws its combustion air from under the home via a combustion air duct and vents the flue gases through the standard roof jack. This furnace must be installed with the MA-100 or MA-200 base, the SRJ series roof jack, and the vent pipe used in conjunction with the SRJ roof jack to meet U.L. requirements.

⚠ WARNING
This furnace must be installed by a qualified installing agency and in accordance with local codes and ordinances. Failure to properly install the furnace, base assembly, and venting system as described in the Installation Instructions may damage the equipment and/or the home, can create a fire or asphyxiation hazard, violates U.S. Listing requirements, and will void the warranty.

Testing the Electrical Polarity (See Figure 3)

1. See line voltage connections on unit wiring diagram in the back of this manual.

⚠ CAUTION
Be careful to avoid electrical shock hazard.

2. With power on at the fuse box, test the line voltage conductors to the ground with a voltmeter set on the proper scale.
 - a. L1 to ground should read 120 Volt AC $\pm 10\%$.
 - b. Neutral to ground should read zero volts.
 NOTE: Test with power on and conductors disconnected from furnace connections.
3. If a reading other than above is read, reverse conductors.

NOTE: If 120 volts AC + 10% is not read, check power source.

Door Switch (See Figure 3)

The door switch is a safety that will shut off 120 volt power to the furnace when the furnace door is open. It is a 2 position switch.

1. Open furnace door.
2. Attach the voltmeter to the door switch. 120 volt + 10% should be read.
3. Push in on the door switch the reading should go to zero volts.

Remove Door Switch

1. Shut off power to furnace.
2. Disconnect 2 electric wires.
3. Press in at top and bottom of switch.
4. Remove door switch.
5. To reinstall, reverse steps 1 to 4 above.

Fan and Limit Switch Combination (See Figure 4)

Testing the Limit Switch (See Figure 5)

When testing the limit switch with a voltmeter, a 120V +/- 10% reading indicates the switch is open and defective. The limit switch should be replaced if cooled below switch setting.

1. Turn off electrical power to the main power source.
2. Disconnect wires from limit switch located inside of control panel. See wiring diagram, located in control panel.

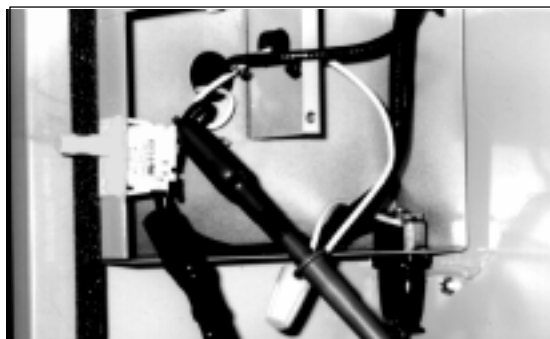

Figure 3



Figure 4



Figure 5

3. Using an ohmmeter, connect leads to limit switch terminals.
4. If limit switch is below temperature, it will read continuity. If there is not continuity, replace limit switch by removing two 1/4" screws.

Removing the Limit Switch

1. Turn power off to the unit.
2. Unwire electrical supply.
3. Remove 2, 1/4" screws.
4. To replace, reverse steps 1-3.*

*Limit switch can be either manual or automatic reset. Manual reset limit will be approved on serial date codes of 9706 and later.

Testing the Fan Switch

The steps necessary to check the operation of the fan switch in the air circulation circuit are:

1. Turn off power to unit.
2. Turn voltmeter on and set to scale capable of reading 120V.
3. Place leads from voltmeter on both wires of the fan switch.
4. Turn on 120 volt power supply to furnace. Voltmeter should read 120V ±10%.
5. With voltmeter leads still attached set room thermostat above the room temperature until the burner comes on.
6. Watch the dial on the fan switch as the heat exchanger heats up, the dial should start to rotate. When the fan switch reaches the on temperature setting the blower should come on, and 0 volts should be read indicating a closed switch.

Removing the Fan Switch

1. Shut off power to unit.
2. Remove cover.
3. Disconnect wires.
4. Remove 3, 1/4" screws.
5. To replace, reverse steps 1-4.

Testing Fan Blower Motor (See Figure 6)

1. Check for 120 Volts + 10%.
2. Check amperage while unit is running.
3. Visually inspect wheel and motor mounting.

Removing Blower Motor

1. Turn off power to furnace.
2. Disconnect power wires.
3. Remove two 1/2" screws.
4. Slide blower out.
5. Remove 3, 3/8" screws.
6. Remove blower and blower wheel.
7. Remove blower wheel.
8. To reinstall, reverse steps 1-7.

Testing The Oil Burner (See Figures 6, 7 and 8)

The two manual resets should be checked before testing any other CMF Furnace Component. These are the Primary Control and the Burner Motor Manual reset.

Check the incoming power with a voltmeter. Set the voltmeter at the proper scale, a 120V \pm 10% should be obtained. If not, check at power cord:

1. Shut off power to the unit.
2. Remove Electric Panel Cover 1, 5/16" screw.
3. Remove 2 wire nuts.
4. Attach voltmeter to incoming power.
5. Turn on power to the unit.
6. Read voltage 120 +/- 10%.
7. Turn off power and reverse steps 1-3.

Test Oil Pump

The fuel(s) used in the oil gun pressure burner applications are No. 1 Fuel, and No. 2 Fuel. It is recommended to use #1 where temperatures fall below 32°.

The oil storage tank may be installed either above or below grade. Check local or state codes. To prevent abnormal tank pressure during fill, the vent pipe should be 1" to 1 1/4" round. On single line systems, bleed all air out of the fuel supply system before lighting the furnace.

Test fuel pump resistance or vacuum with a vacuum gauge. If vacuum reads greater than 10 inches, look for kinked tubing, a plugged oil filter, undersized line, excessive oil lift, heavy oil or a frozen line.

Maximum Values for Vacuum Hq.

Single Stage - Single Line (M units)	6"
Single Stage - Two Line (M units)	10"
Two Stage (2 M units)	15"

The second fuel pump test is to check the pump efficiency or capacity. With the burner running, the efficiency is satisfactory if the oil pressure can be adjusted to 140 PSI. After checks, adjust the oil pressure for normal operation to 100 PSI.



Figure 6

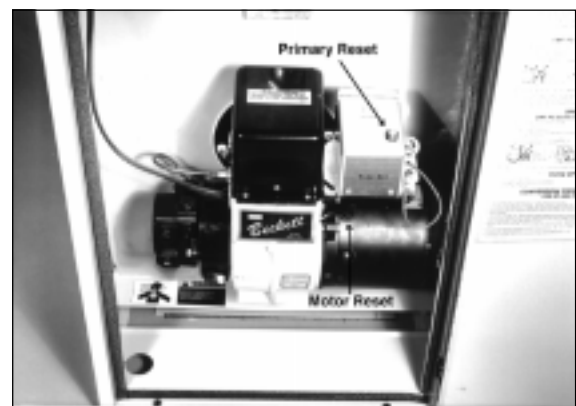

Figure 7



Figure 8



Figure 9

The third fuel pump test is for cut-off. Start the burner and after a few moments of operation shut off the burner. Upon shutdown, pressure should drop approximately 15 to 20 PSI. The two common reasons for inefficient cut-off on fuel pumps are a defective check valve ball in the pump, or poor connectors allowing air into the piping system.

Replacing Oil Pump (See Figure 19, page 8)

1. Shut off and disconnect power to the unit.
2. Shut off oil to pump.
3. Remove oil line.
4. Using a 7/16" wrench, loosen oil lines from pump open to drain assembly.
5. Remove oil lines from pump and move out of the way.
6. Remove 1/4" x 20" x 7/8" hex head screws with 3/8" open end.
7. Pull pump out slowly.
8. To replace, reverse steps 1-7.

When installing single-line systems, the only connections on the burner fuel pump is at the intake port. It is important not to install the "by-pass" plug in the fuel pump return port. A quick rule which can be used for checking an installation with the oil storage tank below the fuel pump is to figure:

1. 1" of vacuum for every 10' of horizontal run.
2. 1" of vacuum for every 1' of vertical lift.
3. 1/2" of vacuum for every 90° elbow fitting.

The single-stage design is used in applications requiring 10" of vacuum or less. Two-stage pumps are specified when up to 15" of vacuum is required. If an oil fuel pump is not properly sized to the vacuum requirements the following will occur:

1. A solid column of oil will not be delivered to the atomizing nozzle.
2. The light portions of the oil will separate from the heavy portion.
3. A milky appearance will be seen in the returned oil.

Conversion from Natural Gas to Propane

⚠ WARNING

Before beginning conversion, shut off electrical power to the furnace at the main power source. Shut off gas supply.

1. Disconnection
 - a. Low voltage wires
 - b. Shut off gas to appliance and remove piping to gas valve.
2. Remove 3, 3/8" bolts from U-shaped manifold plate and orifice assembly. (See Figure 4, Page 19)
3. Replace alternate fuel orifice. Using a 1/2" open end wrench, remove the main orifice and replace it with the alternate fuel orifice supplied in the plastic bag with the burner (located with the home owners packet.)
4. Invert the regulator cap. Warning: check for proper orifice size listed on furnace rating plate.
5. To reinstall, reverse steps 1-4. Manifold pressure would then be set to 11.0" W.C. for LP gas.

Changing Complete Burner Assembly (See Figures 1, page 18 and Figures 2-4, page 19)

1. Open furnace door.
2. Using a 7/16" open end wrench, remove three burner nuts. Remove burner assembly from furnace.
3. To replace burner, reverse steps 1 & 2.

NOTE: Be certain to install new gasket.

Remove Burner and/or Ignitor

1. Shut off gas supply
2. Remove gas lines from Gas valve.
3. Unplug ignitor.
4. Remove 3, 1/4" screws. Lift burner up and out.
5. Remove 1, 1/4" screw and replace ignitor.
6. Set gap distance between ignitor and burner head at 1/2" - 5/8." Micro amp signal should be between 2 to 4 micro amps (µ).



Figure 10

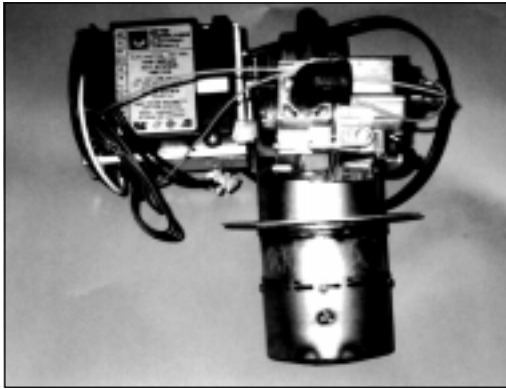

Figure 11



Figure 12

Remove Hot Surface Ignition Series (See Figure 12)

1. Shut off power to the furnace.
2. Remove all wires 24 volt and 120 volt.
3. Remove 2, 1/4" screws.
4. To remount, reverse steps 1-3.

Removing C Burner Motor (See Figure 4, page 19)

1. Shut off power to the furnace.
2. Remove wires from HSI control.
3. Remove 4, 1/4" screws and HSI control.
4. Remove 2, 1/4" screws and panel cover.
5. Disconnect wires to motor; 2 red and 2 black.
6. Remove 1, 5/8" screw from housing strap and lift off motor.
7. To reinstall, reverse steps 1-6.



Figure 15

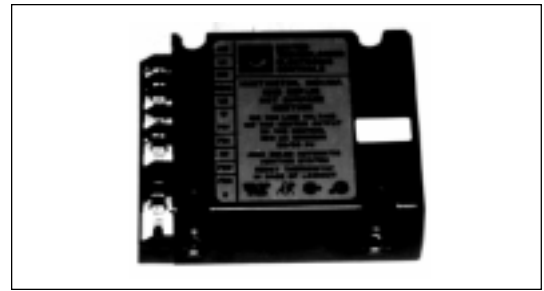

Figure 13

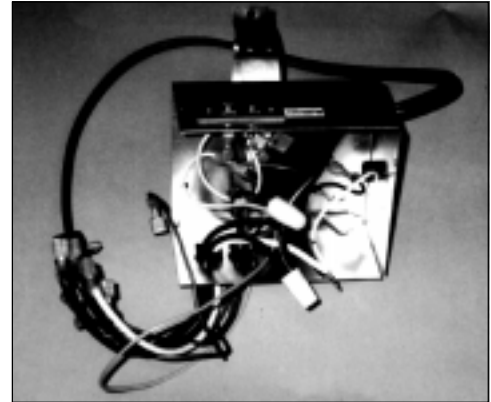

Figure 14

Removal of Air Housing, Blower Wheel and Motor (See Figures 14 - 16)

1. Shut off power to unit.
2. Remove elect wires.
3. Remove 4, 1/4" screws (2 on each side of air housing).
4. Remove band screw, 5/16" bolt.
5. To replace, reverse steps 1-4.

The 3 circuits of the primary control (see Figure 14) are the Starting Circuit, Safety Circuit, and the Running Circuit.

Testing the Primary Control Circuits

1. Shut off power to the unit. Close off oil supply.
2. Remove thermostat wires from T1 and T2 and cad cell wires from F1 and F2.
3. Turn on power to the unit.
4. Jumper out terminals T1 and T2 to test the starting circuit. The burner should come on and then shut down after 45 seconds as the safety circuit engages.



Figure 16

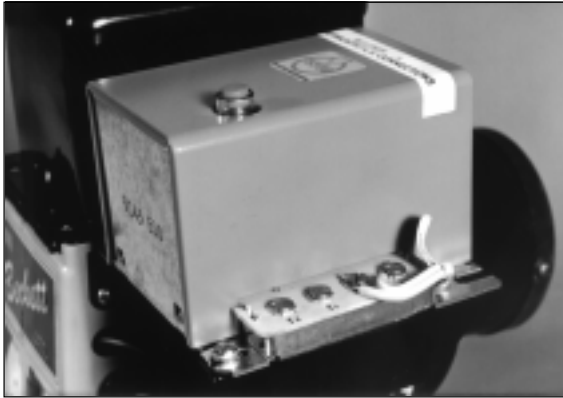

Figure 17



Figure 18

5. Remove jumper wires and allow two minutes for the safety heater to cool off.
6. Test running circuit by jumpering out T1 and T2 and reset the primary control. The burner will come on.
7. Immediately jumper F1 and F2 to bypass the cad cell. The burner should run continuously after 45 seconds with the cad cell safety circuit by-passed.
8. Shut off power to the unit, remove all jumpers, and then reconnect the thermostat and cad cell.
9. If any one of these test fails, replace the primary control.

Removing the Primary Control

1. Shut off power to the unit.
2. Open ignition transformer by removing 2 5/16" screws.
3. Remove the black, white and orange wires leading from the primary control.
4. Remove cad cell wires from F1 and F2, and remove thermostat wires from T1 and T2.
5. Loosen 2, 1/4" screws and remove primary control.
6. To replace, reverse steps 1-5.

Testing Cad Cell

The cad cell is a light sensing resistor. Its function is to cut power to the burner motor in the event the electrodes fail to establish flame.

To check the CAD cell start the burner and unhook both cad cell leads from the FF terminals on the primary control. After the burner lights jump the FF terminals to keep the burner running. Measure the ohms resistance across the cad cell lead as it views the flame. This should be 1,600 ohms or less. A preferred reading is 300-1000 ohms. Next, with the meter still connected to the cad cell leads, turn the burner OFF. The

dark condition should give a reading of 100,000 ohms or infinity. If the reading is lower, let the refractory cool down or look for stray light that might be entering the burner through the air inlet, or around the transformer base plate. If the cad cell is not performing within these guidelines, replace it.

Removing the Cad Cell (See Figures 17 and 18)

1. Shut off power to the unit.
2. Remove wires from primary control.
3. Open ignition transformer.
4. Turn cad cell 1/2 turn in retainer and lift out.
5. To replace, reverse steps 1-4.

Testing Ignition Transformer (See Figure 20)

! WARNING

In testing the ignition transformer extreme caution should be exercised because 10,000 to 14,000 volts are present.

The most common field test of the ignition transformation spark is using a service test cord connected to the primary winding wiring and an INSULATED screw driver. The tests should indicate an arc:

1. 1/2" long ARC from the terminal post to the casing.



Figure 19

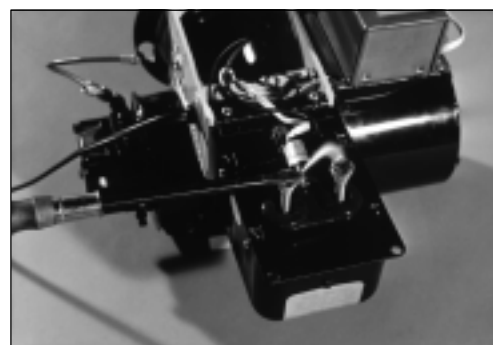

Figure 20

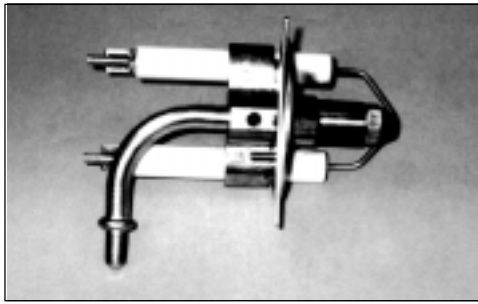

Figure 21

2. 1/2" long ARC from the alternate terminal post to the casing. The first test of the ignition transformer is to check for continuity using an ohmmeter. An infinity reading indicates a defective transformer. A 10,000 volt voltmeter is recommended to test the ignition transformer spark.
3. 1" long ARC from terminal to terminal.

Removing the Ignitor Transformer

1. Shut off power to the unit.
2. Remove white and black wires coming from transformer.
3. Loosen 2, 5/16" screws and turn on tie-down plates.
4. Fold back transformer and remove 2 Phillips head screws and transformer.
5. To replace, reverse steps 1-4.

Electrode Setting (See Figure 21)

The electrode setting is carefully checked at the factory. When servicing the burner electrodes, three procedures should be performed:

1. Set the spacing.
2. Set the gap.
3. Remove the carbon accumulation.
4. Refer to Installation Instructions.

Removing Drawer Assembly

1. Shut off and disconnect power to unit.
2. Remove copper oil line from drawer assembly and loosen at pump using a 7/16" open end wrench and move out of way.
3. Mark position of lock plate.
4. Loosen 5/16" screw on lock plate.
5. Remove drawer assembly and set the spacing, gap and remove any carbon accumulation.
6. To replace, reverse steps 1-5.

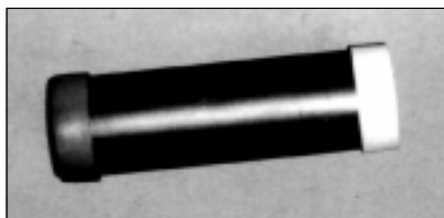

Figure 23



Figure 22

The three functions of the atomizing nozzle are atomization, creating the oil spray pattern and metering the fuel. (See Figure 22.)

Several precautions should be observed when installing an oil nozzle. (See Figure 22).

1. Do not clean a dirty nozzle, replace it.
2. Do not bump nozzle with a wrench.
3. Do not touch nozzle with your fingers.
4. Install nozzle with a nozzle wrench.
5. Be sure strainer is in place and tight.
6. Do not over-tighten nozzle during installation.

Low Burner Pressure and Poor Combustion

A flex coupler can contribute to low burner pressure and poor combustion if the following occurs:

1. The coupler is too long and causes a high amperage burner motor reading.
2. The coupler is worn and slipping.
3. The fuel pump shaft is worn and rounded causing the coupler to slip. (See Figure 23)

The proper mixture of fuel and air is delivered to the burner through an air adjustment band located on the burner housing. (See Figure 24)

The primary purpose of the combustion chamber liner is to isolate the combustion process from the rest of the furnace and prevent damage to the components and the cabinet.

Removing Combustion Air Adjustment Band

1. Remove oil pump. (See oil pump replacement.)
2. Remove 2 5/16" screws from air band.
3. Loosen 1 5/6" screw and remove band housing.
4. To replace, reverse steps 1-3.



Figure 24

Removing Motor and Blower Wheel

1. Shut off power to the unit.
2. Open transformer.
3. Remove motor wire.
4. Remove 2, 3/8" screws.
5. Remove motor and blower wheel.
6. Loosen 1/8" Allen screw and remove wheel. The wheel will be down 3/4" on the shaft.
7. To replace, reverse steps 1-6. (See Figure 9, page 6 and Figure 16, page 7)

Installation Instructions CB-200A Base

The model CB-200A (901696) base allows for a non-sealed combustion, central heating (without warm air ducts) installation of the CMF Series furnaces. This installation must be done by a qualified installing agency in accordance with local codes and ordinances.

Location

Allow clearance from adjacent materials as stated under "Minimum Clearances." Ample clearance should be provided to permit easy access for removal of filters, blower, motors, controls and vent connections. Unit must be installed in a level position on NORDYNE base model CB-200A.

Minimum Clearances To Adjacent Materials

The furnace may be installed in a corner, or against an open wall with the clearances not less than: Front 36 inches; Top 17 inches; Vent 9* inches for oil units, 6 inches for gas units; 3* inches for rear; and 2** inches for one side if in corner.

* Rear clearance may be 0 inches but vent clearance will be reduced to 6 inches. Refer to table 8, appendix B of NFBA No. 31 for requirements to achieve 6 inches vent clearance.

** The minimum clearance from warm air register in base must be 36 inches. Use a 15 5/8" L x 7" W sheet metal blank off panel to replace register when clearance is less than 36 inches.

Venting (CB-200A Base)

Unit must be vented through a permanent chimney or 4" type L, low temperature venting system (oil units) or 4" type BW venting system (gas units) selected and installed by the installer. Check chimney for soot, leaks, obstructions and proper height. If it is necessary to construct a new chimney, local conditions such as necessary height, draft, and number of appliances served should be checked with local building codes.

Horizontal distances to an existing chimney should be as short as possible and the connecting pipe should slope upward to the chimney at not less than a 45° angle. Total length of the sloping pipe must not exceed 6 feet.

Barometric regulator (oil units)* is to be installed at the vent connection of the furnace. All flue pipe joints should be fastened with sheet metal screws for rigidity.

To prevent down-draft, the chimney should extend at least 2' above the peak of roof. The internal area of the chimney should equal the area of the flue outlet on the furnace. The chimney should have no obstructions or sharp bends where soot and other foreign matter can accumulate. If inspection shows it to be obstructed, the chimney should be cleaned. The existing flue pipe should be cleaned or a new pipe should be installed. Connect the flue pipe to the chimney with few elbows as possible. Do not install hand dampers of any type.

It is desirable that the furnace flue serves no other appliances. However, when two or more appliances must vent into a common flue, the area of the common flue should at least equal the area of the largest flue connector, plus 50% of the area of the additional flue and vent connectors. The flue or vent connector must be inserted into, but not beyond, the inside wall of the chimney flue liner.

Provisions must be made for adequate ventilation to properly support combustion and to maintain safe ambient temperatures.

When buildings are so tight that normal infiltration does not meet air requirements, one or more permanent openings must be provided to supply outside air. The minimum cross section of the duct is to be 1 sq. inch area-free for each 2000 Btuh input for horizontal duct installations, or 4000 Btuh input for vertical installations. Refer to gas code book.

Installation

Base: The base must be located on a hard surface. When the furnace location is carpeted, use a hard surface platform under the base.

Furnace: Set the furnace on the base without damaging the foam gasket material on the base top. Making sure the furnace is seated on the back of the base, fasten the front of the furnace to the base with 1/2" long sheet metal screws.

NOTE: Front register is not adjustable and remains fully open.

Fuel line piping, wiring, and thermostat: Refer to the installation and operation manuals provided with the furnace.

DANGER: When using CB-200 A (Cottage Base), do not install the furnace in a mobile home. Do not install the furnace in a closet, alcove or other enclosed area. Violation of the above may cause incomplete combustion which may produce poisonous gases causing asphyxiation and resulting in sickness or death.

Testing Combustion Efficiency With Bacharach Test Kit

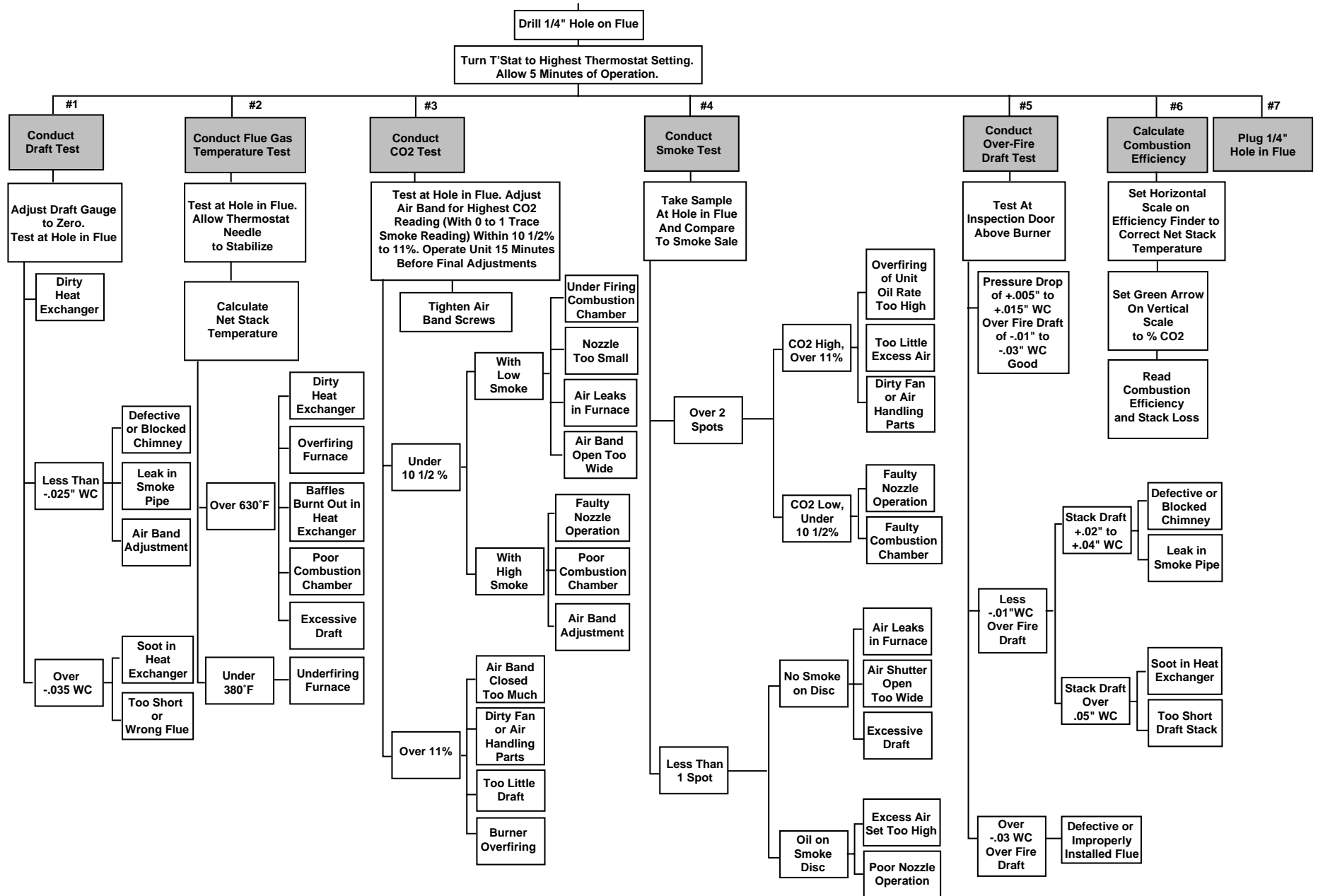

Oil Burner Operation Complaints

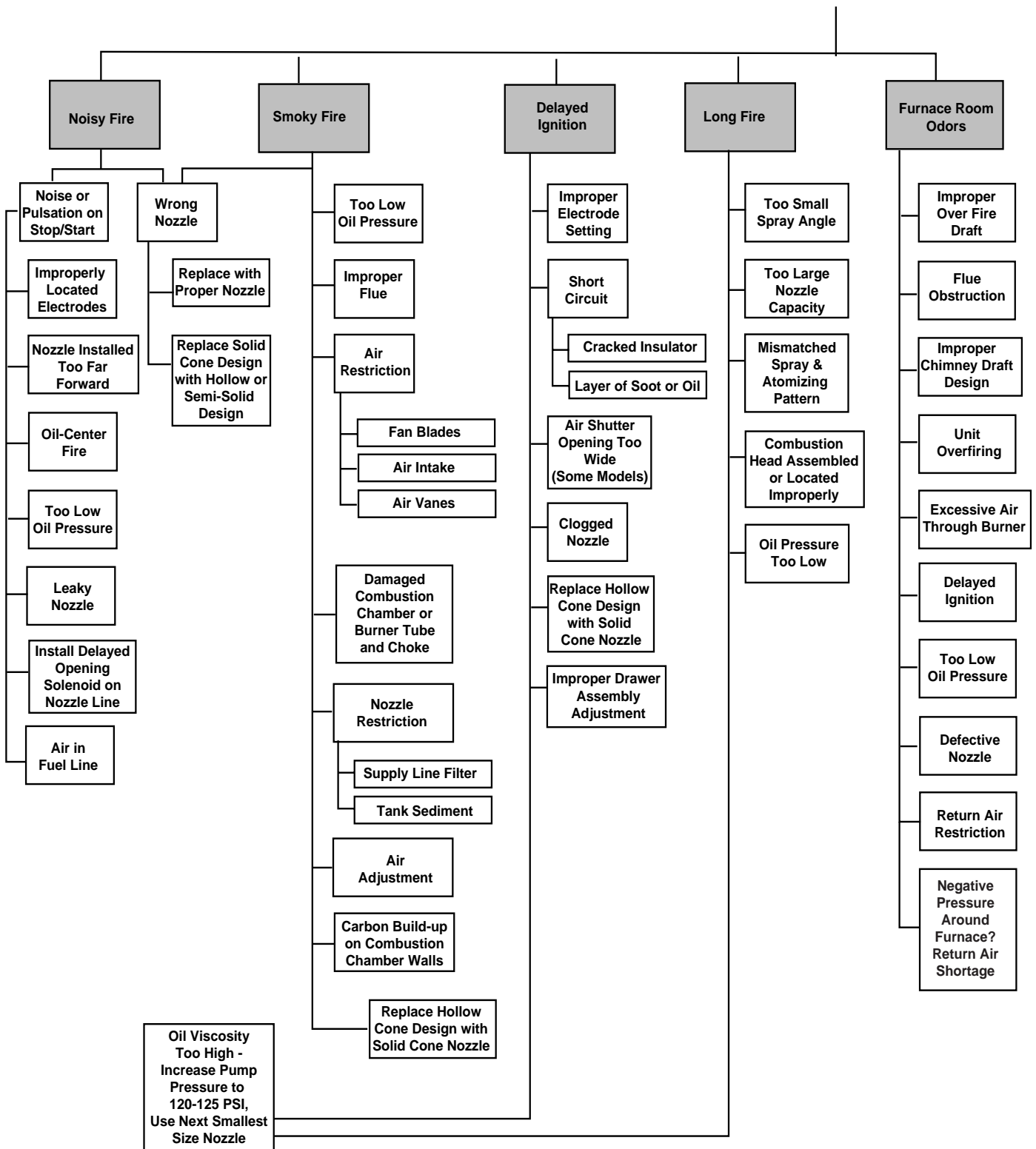

Oil Burner Operation Complaints

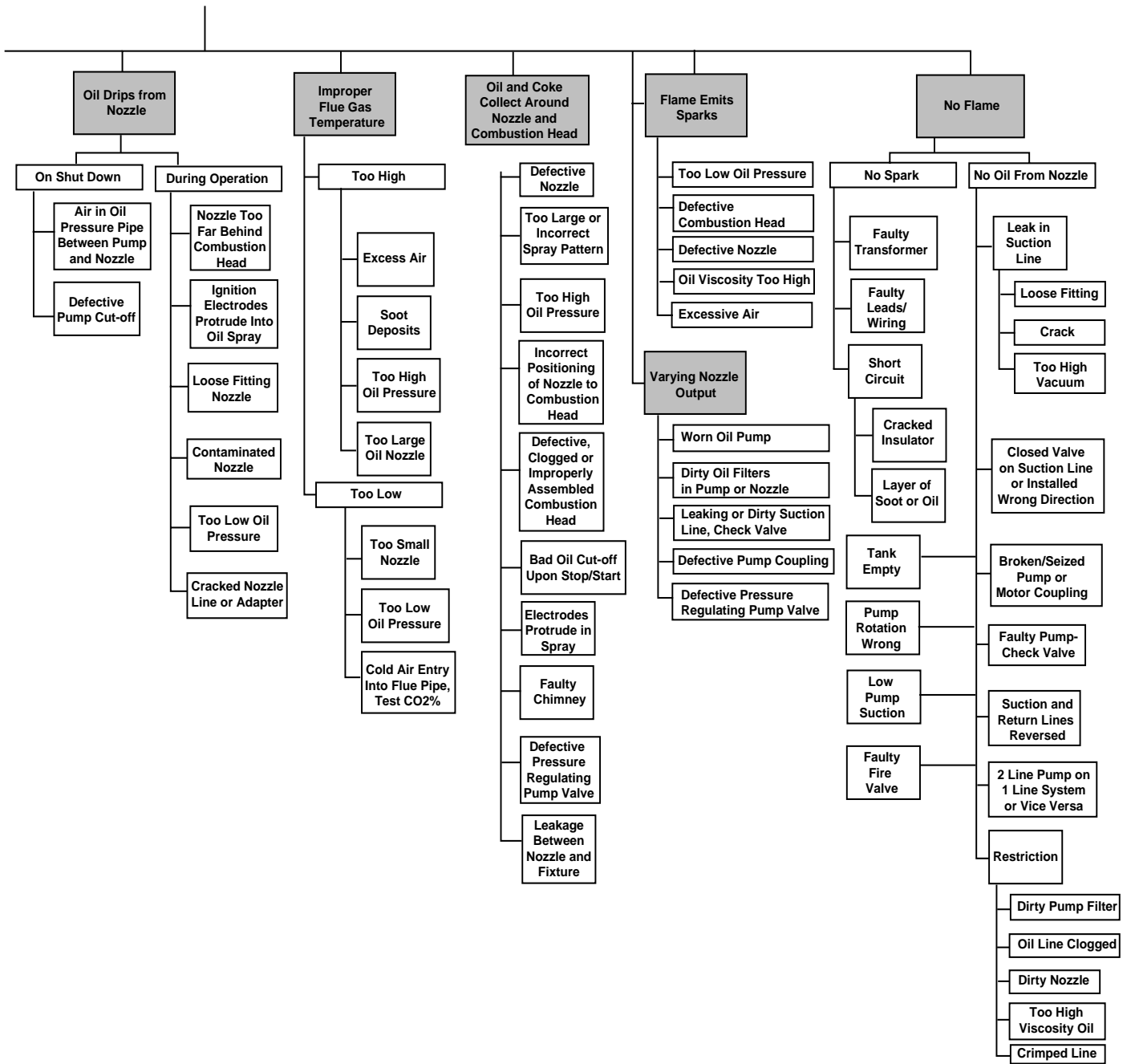

Testing Faulty Fuel Delivery

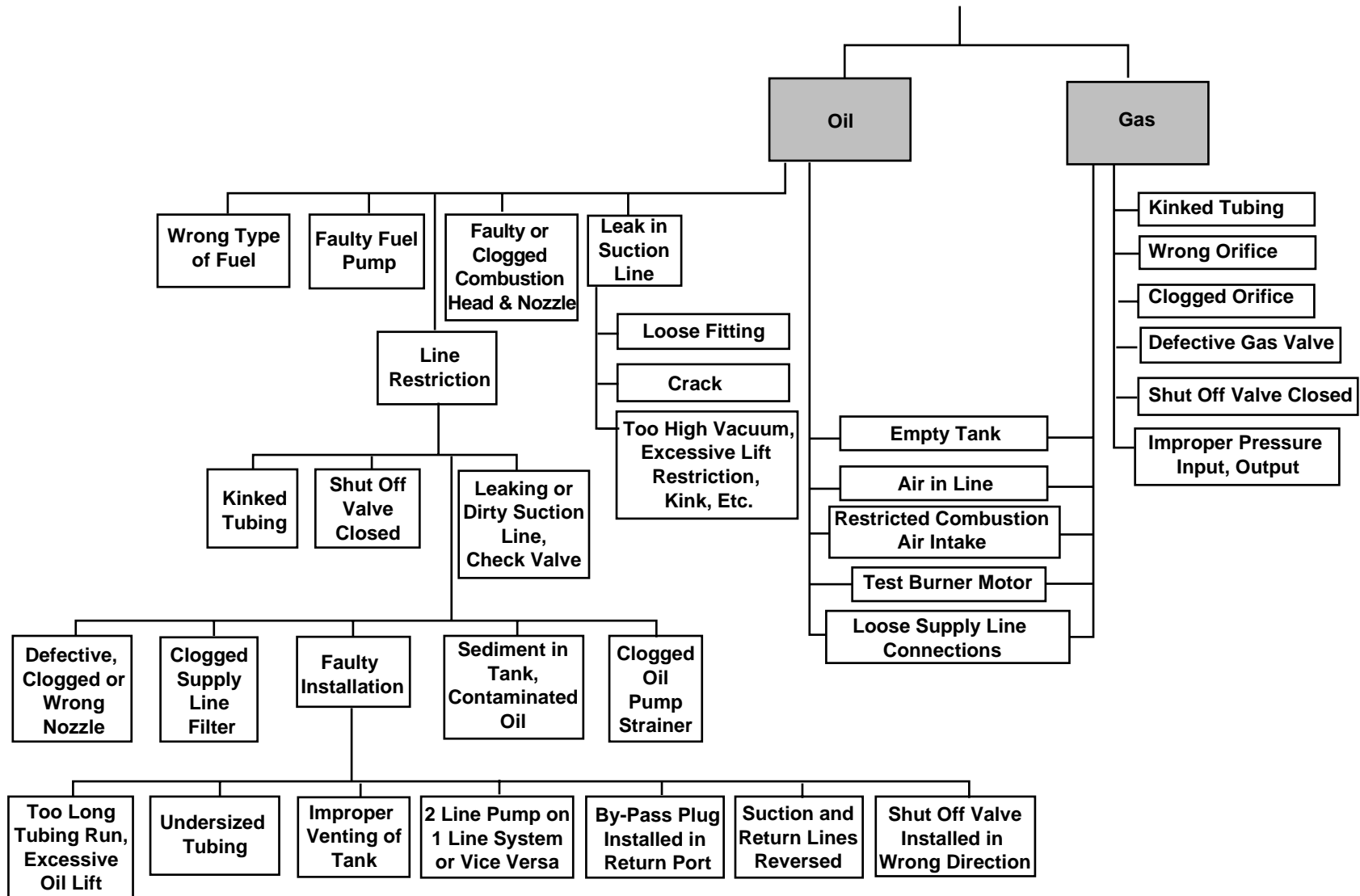

Testing Fuel Pump

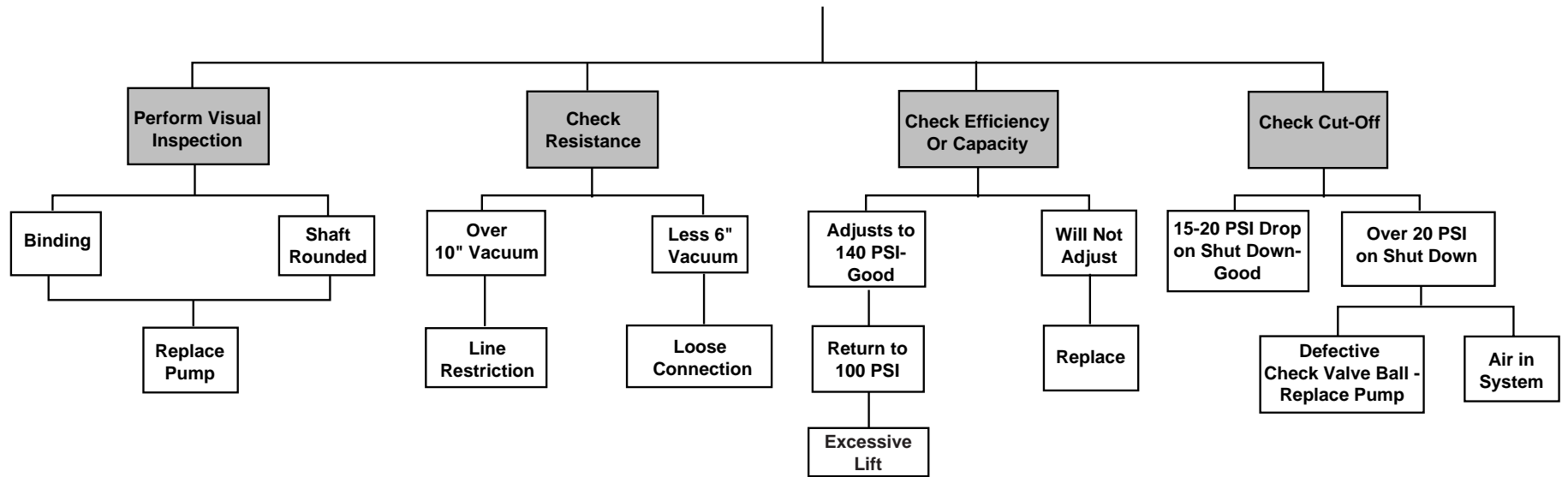

Service Guide For Furnaces with PGB Power Burner with Direct Ignition

Burner motor does not run - thermostat calls for heat

1. Defective thermostat circuit - bridge TT connections on burner junction box, if burner motor runs, check:
 - a. Thermostat connections
 - b. Thermostat
2. No voltage to burner - plug test lamp into burner plug receptacle, if it does not light, check for:
 - a. Blown fuse, electric supply off
 - b. Door switch not making contact
 - c. Limit switch in open mode
 - d. Check for clean air filter and proper airflow
 - e. Loose wire connections
 - f. Check for tripped manual reset auxiliary limit.
3. 120 volts is available to burner - Test lamp does not light. Remove junction box cover on burner, check for:
 - a. Loose wires
 - b. Defective transformer
 - c. Defective motor

Burner motor does not run, no main flame

1. Defective centrifugal switch
 - a. Check the operation of centrifugal switch by removing end bell of the burner motor.
 - b. If the contacts are accessible, clean them.
 - c. If the contacts are accessible, replace motor as on some burner motors the centrifugal switch cannot be replaced.
2. Burner in purge mode - allow 3 minutes for burner to establish flame.
3. Check for proper electrical connections at purge timer, control box or gas valve.
4. Check for gas supply - gas line valve on, control lever on.
5. Check for burner safety lockout. (Restart burner)
6. Check for 24 volts to ignition control
 - a. No voltage at purge timer - check the centrifugal switch in the combustion motor.
 - b. No voltage to ignition control - check purge timer (allow one minute for purge timer to activate).
 - c. Check for 120 volts to ignition control. (-Voltmeter at L1 and L2).

Ignition control is powered (120v and 24v).
Ignitor does not heat up

WARNING:

When replacing the ignition control, replacement control **MUST** have the safety lockout time. **FAILURE TO FOLLOW THIS WARNING MAY RESULT IN AN EXPLOSION.**

IMPORTANT:

1. Always disconnect power before servicing.
2. Only persons trained and experienced in direct ignition systems should service this equipment.
3. If a condition exists that causes the ignition control to go into safety lockout, meter readings must be taken quickly after restart - within trial for ignition period.
4. Always de-energize the system for at least 45 seconds before recycling for further tests.
5. The ignition control cannot be repaired. If the troubleshooting procedure indicates a malfunction in the control, it must be replaced.

1. Remove AMP plug from burner tube receptacle and check for 120 volts at the plug during ignition sequence (allow 3 minutes for ignition cycle).
2. Replace ignition control if 120 volts is not supplied to AMP plug within 3 minutes of ignition cycle start.

120 volts is available at AMP plug Ignitor does not heat up

1. Disconnect burner plug from furnace receptacle.
2. Disconnect AMP plug from burner tube receptacle and check ignitor circuit through receptacle with an ohmmeter.
 - a. Normal ohm reading should be 40 to 75 ohms.
 - b. An infinite or zero ohm reading indicates a defective ignitor and it must be replaced.
3. Check for continuity from ignitor receptacle to burner ground.
4. Check for hairline cracks in ignitor's insulating ceramic.

Main flame ignites but burner locks out

1. Ignition control is not properly grounded.
2. Defective ignition control.
3. Improper gas pressure or burner air adjustment is not allowing flame to contact ignitor tip for flame proving rectification.

24 volts supplied to gas valve during ignition but no main gas flow

1. Gas valve may be defective. Replace if necessary.
2. Gas piping may be plugged. Check for adequate gas supply to gas valve at union.

Burner operates, insufficient heat

1. Check the thermostat for proper setting and location. The thermostat should not be located where it will be affected by another heat source. (Lamps, ovens, sunlight, etc.)
2. Check for clean air filters and proper air flow.
3. Check burner for proper gas firing rate.
4. Be sure unit is not undersized for its thermal load.
5. Check thermostat anticipator. (0.9 amps)

Burner does not shut off

Note: Burner will stop when the door switch is open. With the door open, secure the door switch in the closed position by depressing the switch. The means for securing the door switch must be removed once this testing has been completed.

1. Disconnect the thermostat wires from TT connections on the burner junction box. If the burner shuts off, check for:
 - a. Short circuit in the thermostat wires.
 - b. Defective thermostat.

Burner flame without motor running

Gas valve is stuck in open position - Replace the control, burner and heat exchanger may need cleaning.

Noisy fire

Readjust combustion air to reduce volume of air being drawn into the burner. (Caution: See burner adjustment)

High Gas Bills

1. Check the combustion air adjustment.
2. Be sure the proper size orifice is being used.
3. Be sure the return air filter is clean.
4. Be sure the home is insulated, windows and doors fit tightly, and there are no air leaks in the heating ducts.
5. Check room thermostat to be sure the setting is not higher than necessary. Low humidity requires higher temperatures for comfort. Perhaps humidity should be increased.

Circulation blower will not operate even though the burner operates

1. Turn on the manual blower switch. If the blower operates, check the fan switch.
2. Check the wiring to the motor.
3. Check for a burned out motor.

CMF Oil to Gas Conversion

⚠ WARNING:

This furnace must be installed by a qualified installing agency and in accordance with local codes and ordinances. Failure to properly install the furnace, base assembly and venting system as described herein may damage the equipment and/or the home, can create a fire or asphyxiation hazard, violates U.S. listing requirements, and will void the warranty. This furnace is NOT approved for installation with split system air conditioning. Use a NORDYNE packaged air conditioning system.

⚠ FOR YOUR SAFETY:

Do not store gasoline or other flammable vapors and liquids in the vicinity of this or any other appliance.

⚠ WARNING:

Improper installation, alteration, service or maintenance can cause injury or property damage. Refer to this manual. For assistance or additional information consult a qualified installer, service agency, or the gas supplier.

⚠ FOR YOUR SAFETY:

WHAT TO DO IF YOU SMELL GAS

- Do not try to light any electrical switch; do not use any phone in your building.
- Immediately call your gas supplier from a neighbor's phone. Follow gas supplier's instructions.
- If you cannot reach your gas supplier, call the fire department.

Before installing the power gas burner, removal of present burner is required. (See Figure 2.)

1. Shut off electric power supply to furnace. Remove power cord from 120v receptacle, remove low voltage (thermostat) wiring from primary control connections.
2. Shut off fuel supply to burner, close line or tank valve if applicable. Disconnect fuel line at inlet fitting on burner pump and remove fuel line.
3. Loosen and remove the three (3) 2/16" hex nuts, and remove the burner.
4. Inspect the combustion chamber and heat exchanger for cracks, corrosion, or soot. If signs of sooting are present, the heat exchanger should be cleaned to insure proper draft.

Installing Gas Burner

1. Place new burner gasket on mounting plate. (See Figure 3.) Insert burner tube into heat exchanger through mounting flange. Mount burner on studs, making sure burner will pull up tight to flange, and fasten to mounting flange using the three hex nuts.
2. Reconnect thermostat leads to appropriate connections on burner. Attached power cord may then be plugged into 120v receptacle.
3. Connect gas piping and check for leaks.
 - a. Gas piping should be sized and installed in accordance with local codes and utility regulations.
4. Thermostat - It may be necessary to change the heat anticipator setting. Failure to do so could result in a wide temperature fluctuation in home.



Figure 1.

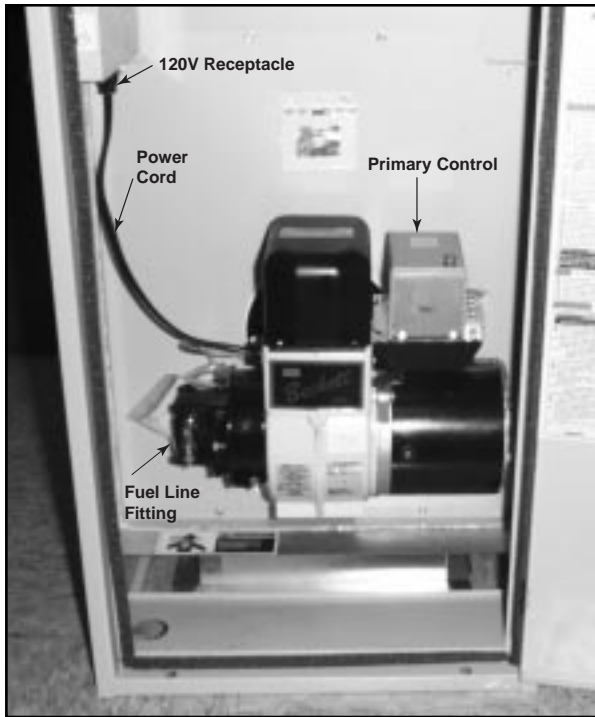

Figure 2.

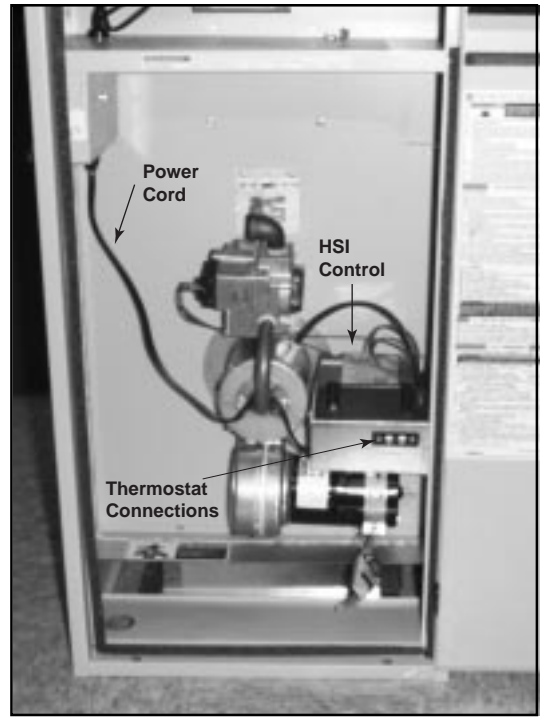

Figure 4.



Figure 3.

⚠ WARNING:

FOR YOUR SAFETY, WHAT TO DO IF YOU SMELL GAS:

- Do not try to light any appliance.
- Do not use any electrical switch, do not use any phone in your building.
- Immediately call your gas supplier from a neighbor's phone. Follow the gas supplier's instructions.
- If you cannot reach your gas supplier, call the fire department. Should overheating occur or the gas supply fail to shut off, disconnect the power at the main circuit breaker and then see "To Turn Off Gas Appliance."

Operation — CMF-PG Series
FOR YOUR SAFETY READ BEFORE LIGHTING OR
OPERATING.

⚠ WARNING:

If you do not follow these instructions exactly, a fire or explosion may result causing property damage, personal injury or loss of life.

1. This appliance does not have a pilot. It is equipped with an ignition device which automatically lights the burner. **Do not try to light the burner by hand.**
2. **BEFORE LIGHTING OR OPERATING:** smell all around the appliance area for gas. Be sure to smell next to the floor because some gas is heavier than air and will settle on the floor.

WHAT TO DO IF YOU SMELL GAS:

- Do not try to light any appliance.
 - Do not touch any electric switch, do not use the phone.
 - Leave the building immediately, then call your gas supplier.
 - If you cannot reach the gas supplier, call the fire department.
3. Use only your hand to push in and move the gas control lever. Never use tools. If the lever will not push in by hand, don't try to repair it, call a qualified service technician. Force or attempted repair may result in a fire or explosion.
 4. Do not use this appliance if any part has been under water. Immediately call a qualified service technician to inspect the appliance and to replace any part of the control system and any gas control which has been under water.
 5. Should overheating occur, or the gas supply fail to shut off, turn off the manual gas valve to the appliance.

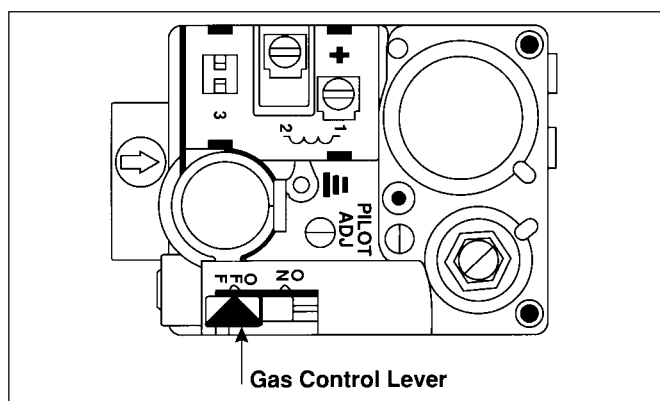

Figure 5. Direct Ignition Gas Valve

OPERATING INSTRUCTIONS – CMF-PG Series with PGB-DI Direct Ignition Burner

1. **STOP!** Read the safety information above.
2. Set the thermostat to OFF or to its lowest setting.
3. Turn off all electric power to the appliance.
4. This appliance is equipped with an ignition device which automatically lights the burner. **DO NOT try to light the burner by hand.**
5. Turn the latch and open the furnace door.
6. Push in the gas control lever and move to OFF. **DO NOT FORCE.**
7. Wait ten (10) minutes to clear out any gas. If you then smell gas, **STOP!** Follow Section B in the safety information above. If you don't smell gas, go to the next step.
8. Move the gas control lever to ON.
9. Close the furnace door and turn the latch.
10. Turn on all electric power to the appliance.
11. Turn the thermostat to ON and set to the desired setting.
12. If the appliance will not operate after one re-try, follow the instructions in the "To Turn Off Gas To Appliance" Section below and call your service technician or gas supplier.

To Turn Off Gas to the Appliance

1. Set the thermostat to OFF or to its lowest setting.
2. Turn off all electric power to the appliance if service is to be performed.
3. Turn the latch and open the furnace door.
4. Push in the gas control lever and move to OFF. **DO NOT FORCE.**
5. Close the furnace door and turn the latch.

Operating Sequence

On a call for heat, the thermostat contacts close which energizes the combustion blower motor. When motor operation reaches 80% of full rpm, the centrifugal switch, located in the motor end cap, closes. A thirty (30) second pre-purge cycle will occur before supplying power (24v) to the gas valve.

When the ignition control is powered, the ignition sequence is started with an internal safe start check. After the safe start check is complete, the control will initiate a timed ignitor warm-up period. During this time, the ignitor is heated to ignition temperature. When the warm-up period is completed, the control will open the gas valve for a timed trial ignition period. The ignitor will light the gas and detect the presence of flame using the flame rectification principle. If flame is detected the control will keep the gas valve open until the call for heat is completed. If no flame is detected, the control will close the gas valve at the end of the trial for ignition period.

The ignition control is equipped with a relight feature. If the flame is extinguished during the run cycle, the control will close the gas valve and repeat the ignition sequence as previously described. Once in lockout, the control can be reset by interrupting the 24 VAC power. This can be easily accomplished by setting the thermostat below room temperature for at least forty-five (45) seconds, and then returning it to desired setting.

If adjusting the thermostat does not reset the ignition control, turn power to the appliance off for forty-five (45) seconds, and then turn it back on.

NOTE: If the gas control has been replaced or serviced, lighting may not be satisfactory until air has been purged from the gas line or the gas input and combustion air have been adjusted.

Checking Natural Gas Input

Check the label on the burner to be sure the burner is equipped with orifices for type of gas being used. Alternate orifices are in bag attached to the burner. Instructions for changing orifices are covered later herein.

To check the input, time the dial on the meter for one revolution while the burner is operating. Be sure to isolate all other gas consuming appliances except pilots. If the time varies more than 5% from the times shown on the chart, check the gas pressure according to the procedure stated in GAS BURNER CONTROLS. If the pressure reading matches the pressure shown on the chart; check to be sure the proper burner orifice is being used. Further gas problems should be referred to the local gas supplier. Natural gas varies in BTU value from 950 to 1,050 BTU per cubic foot. The chart is based on natural gas at an average of 1,000 BTU per cubic foot, burner manifold pressure of 3.5" W.C. and meter dial size of 1 cubic foot.

Burner Model	BTUH Input	Burner Orifice	Time Per Rev.
PGB-1	90,000	No. 16	40 sec.
PGB-2	75,000	No. 20	47 sec.

Table 1.

Checking LP Gas Input

LP gas installations are not usually supplied with meters for determining the amount of gas used. The chart shows the approximate time required per dial revolution if a meter is used that is calibrated for cubic feet delivery. The chart is based on LP gas at an average of 2,500 BTU per cubic foot, burner manifold pressure of 10" W.C. and meter dial size of 1 cubic foot.

Burner Model	BTUH Input	Burner Orifice	Time Per Rev.
PGB-1	90,000	No. 36	98 sec.
PGB-2	75,000	No. 40	117 sec.

Table 2.

Adjusting the Burner

1. Air shutters are factory preset for installation in a given furnace. (See Figure 15) Local conditions may require fine tuning. Rotate the air shutter disc at the left of the burner housing to adjust the combustion air. Rotate the disc counterclockwise to increase combustion air. Rotate the disc clockwise to decrease combustion air.

The combustion air for the power gas burner is taken from the outside of the manufactured home.

Operating at high altitudes — for operation at elevations of more than 2,000 feet above sea level, the input should be de-rated 4% for each 1,000 feet above sea level by reducing orifice size, or decreasing the manifold pressure.

1. Observe combustion flame through observation door on CMF series furnaces immediately after burner is placed in operation. Yellow flame tips should be visible above combustion chamber.
2. Burner should run quietly. Excessive updraft may cause burner to rumble; rotate disc to decrease air supply. (CAUTION: See Note below.)
3. After checking the flame pattern and for noise level, lock disc in position by tightening slotted head screw.

NOTE: It is very important that air supply be ample without decreasing efficiency of burner. An inadequate amount of air can cause carbon monoxide (CO). The carbon dioxide (CO₂) content of the flue products should be in the range of 8.0 to 9.0 percent for natural gas and 9.0 to 10.0 percent for LP gas.

Adjusting Heat Distribution

1. Set the room thermostat for the desired room temperature.
2. Balance the heat distribution by adjusting the register openings.

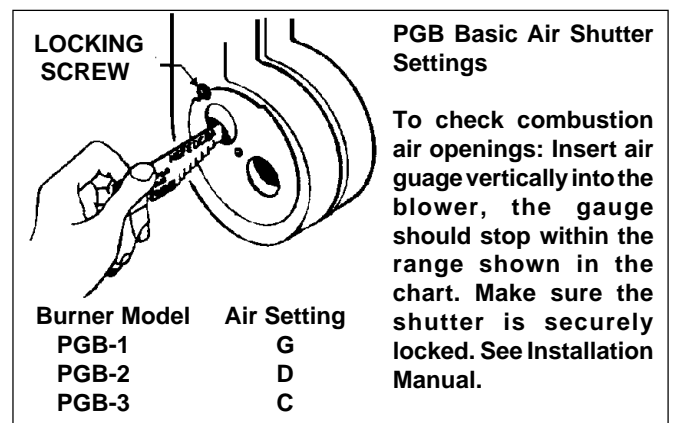

Figure 6. Air Shutter Adjustments for Power Gas Burner

Air Supply for Sealed Combustion

1. Close and latch burner access door to complete the outdoor combustion air passage.
2. If the space below the home is enclosed, be sure a vent or duct of at least 18 square inches of free area is provided from the outside to provide sufficient air for combustion. Make sure the combustion air duct extends through the floor and is unobstructed.

Gas Burner Controls (Direct Ignition Series) Combination Electric Gas Valve and Pressure Regulator

The combination electric gas valve and pressure regulator performs several functions. The gas valve control lever has two positions. The OFF position completely shuts off the gas supply. The ON position allows gas flow through the redundant gas valve when it is energized electrically.

Gas to LP Conversion

This gas fired heating appliance was shipped from the factory for use with natural gas. However, the appliance can be converted to be used with LP gas. Use the following procedure for gas conversion of the burner.

Remove the Burner Assembly:

1. Follow instructions "To Turn Off Gas To Appliance."
2. Shut off gas supply at meter.
3. Disconnect gas burner electric cord, gas piping to burner, and thermostat leads.
4. Remove three (3) hexagon nuts holding burner in place.

Change the Main Burner Orifice:

1. Disconnect inlet pipe union at burner. Disconnect burner power cord.
2. Disconnect the two wires leading to gas control valve.
3. Remove three (3) bolts from U-shaped manifold plate and orifice assembly.
4. Remove the main orifice and replace it with the alternate fuel orifice supplied in the plastic bag with this burner.

Change the Pressure Regulator:

1. Remove the regulator converter and its black cover located on top of the gas valve and invert. (See Figure 16 — For LP, the red ring will be located at the bottom and the "LP" stamping on the converter will appear right side up.)
2. Screw converter back into the regulator, hand tight plus 1/8 turn, and replace the black cover onto the converter top to protect the threads.

Reassemble Appliance:

1. Reassemble the burner assembly into the furnace.
2. Reconnect the gas piping and electrical wires to the gas valve.
3. Open the manual shut-off valve and follow the "Operating Instructions" as outlined previously in this manual to put the furnace into operation.

Centrifugal Switch

The electric motor for the blower which supplies combustion air to the burner is equipped with a centrifugal switch wired in series with the burner controls. This switch is normally open until the speed of the blower motor closes it thereby powering the burner controls. The burner controls will not function until the blower motor is operating at full speed.

Firing Rate Conversion

The rated firing rates of the CMF80 convertible furnaces (PO & PG) can be adjusted from the factory setting of 75,000 BTU/hr.

The firing rate can be changed to either 65,000 BTU/hr. or to 90,000 BTU/hr. using the appropriate certified NORDYNE conversion kit installed by a NORDYNE distributor or Service PRO. See the Replacement Parts Listing for the appropriate kit number to order.

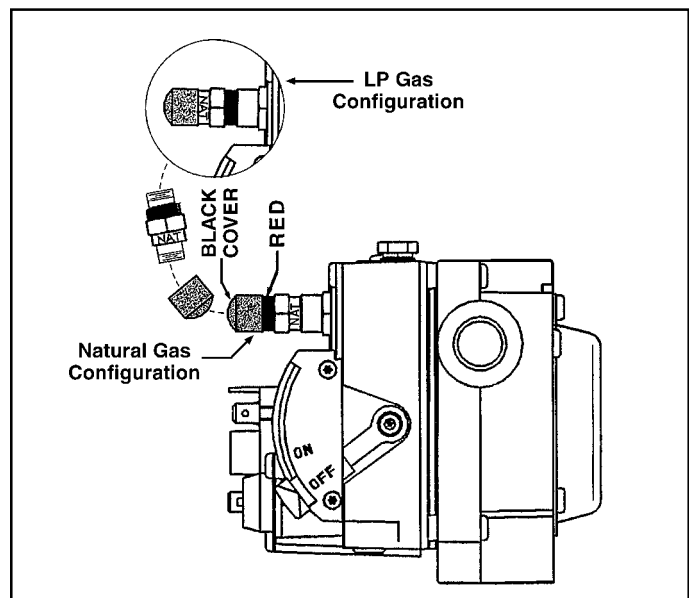
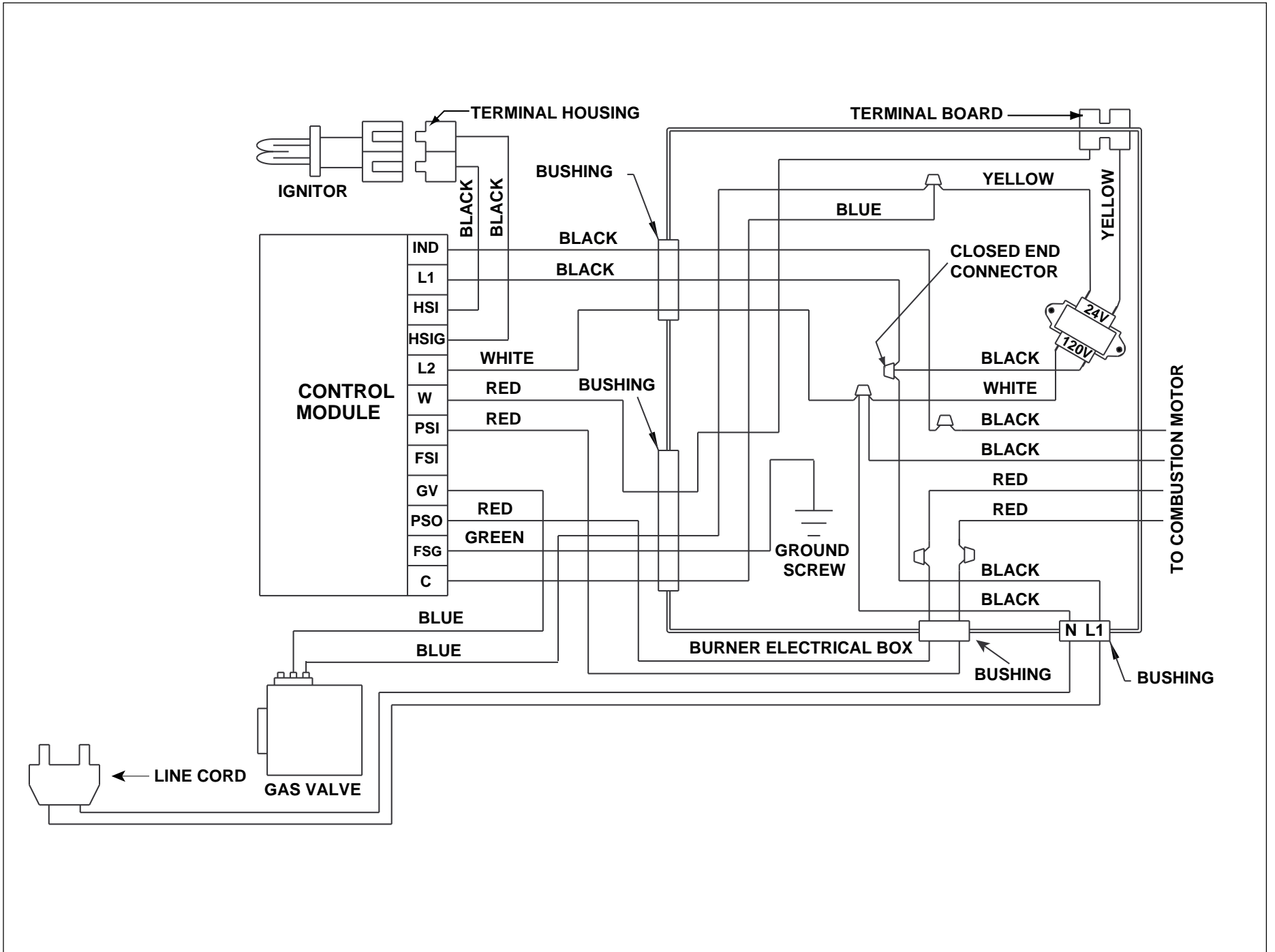
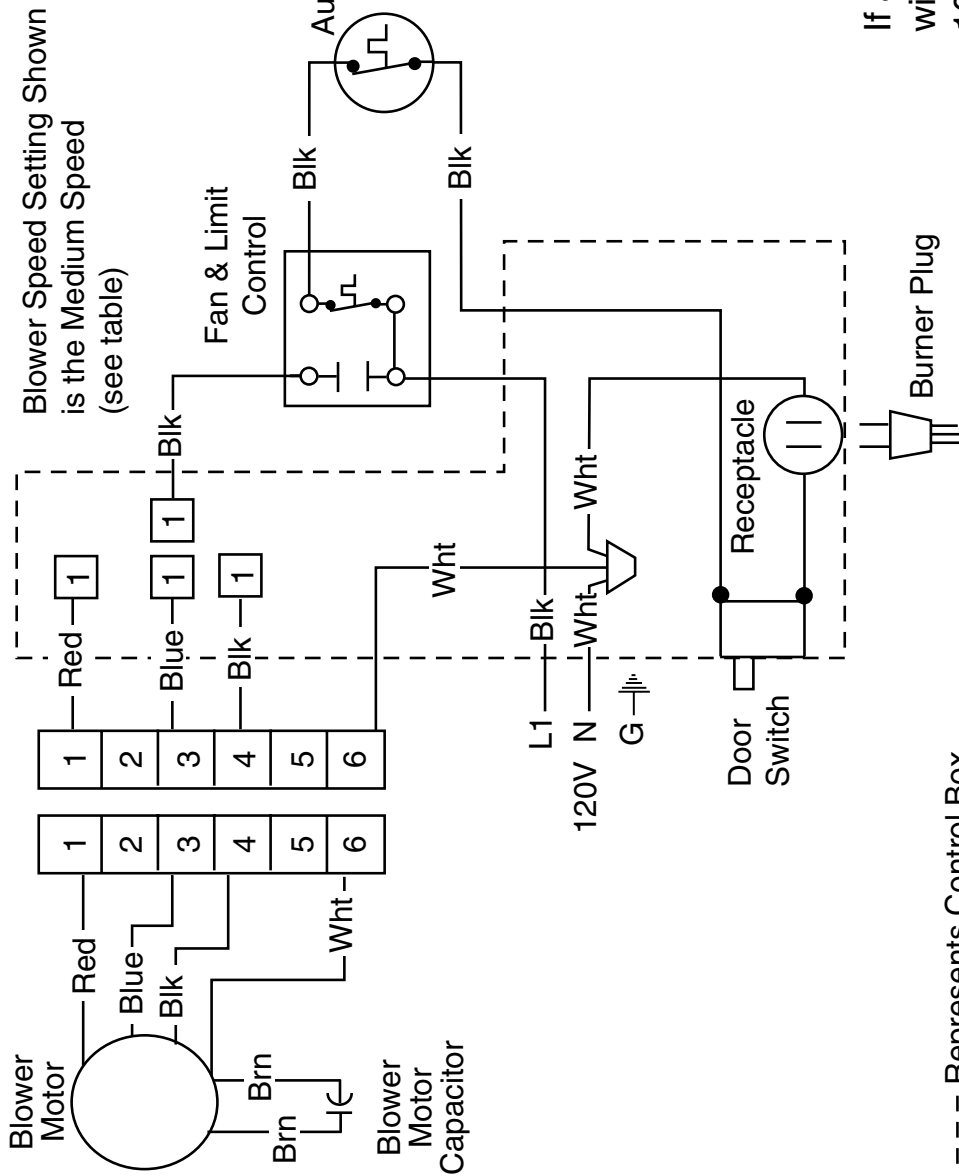

Figure 7. Natural Gas Configuration

Gas Gun Furnace Wiring Diagram



Blower Wire Color	Blower Speed
Red	Low
Blue	Med.
Black	High



If any of the original wire supplied with the appliance is replaced, use 105 C wire or equivalent.

--- Represents Control Box

CMF Wiring Diagram